Facts About SWR, Reflected Power, and Power Transfer on Real Transmission Lines with Loss

Steve Stearns, K6OIK
Northrop Grumman
Electromagnetic Systems Laboratory
San Jose, California
stearns@ieee.org
k6oik@arrl.net

K6OIK's Pacificon Antenna Seminar Presentations

- 2003** Twin Lead J-Pole Design
- 2004** Antenna Impedance Models – Old and New
- 2005** Novel and Strange Ideas for Antennas and Impedance Matching
- 2006** Novel and Strange Ideas in Antennas and Impedance Matching
- 2007** New Results on Antenna Impedance Models and Matching
- 2008** Antenna Modeling for Radio Amateurs
- 2010** Facts About SWR, Reflected Power, and Power Transfer on Real Transmission Lines with Loss

Topics

- **Transmission line distributed parameters**
- **Complex characteristic impedance and propagation constant**
- **Attenuation constant and velocity factor**
- **Relation between attenuation constant and matched loss**
- **SWR variation on lossy lines**
- **Total line loss with unmatched load**
- **Power transfer and loss with lossy lines**
- **Solution for maximum power transfer through a lossy line**
- **Tools and references**
 - Software, books, articles

Oliver Heaviside, 1850-1925



Heaviside's Telegrapher's Equations

Uniform transmission line

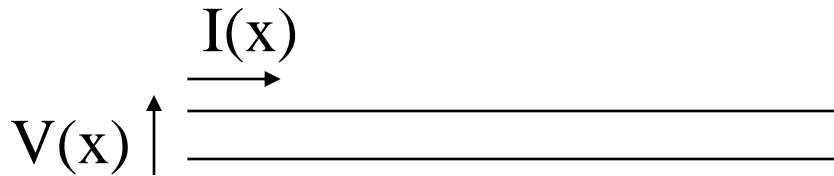

Infinitesimal segment

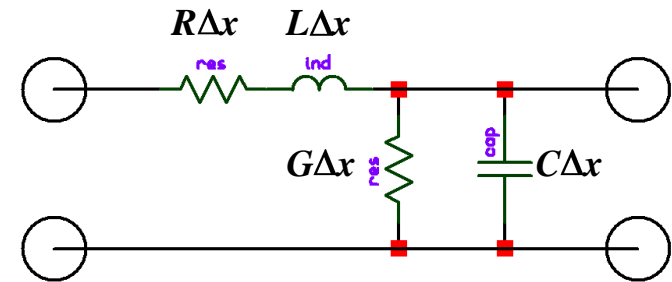

$$\left. \begin{aligned} \frac{dV}{dx} &= -(R + j\omega L) I(x) \\ \frac{dI}{dx} &= -(G + j\omega C) V(x) \end{aligned} \right\} \Rightarrow \begin{cases} \frac{d^2V}{dx^2} = (R + j\omega L)(G + j\omega C)V(x) \\ \frac{d^2I}{dx^2} = (R + j\omega L)(G + j\omega C)I(x) \end{cases}$$

Transmission Line Solution: Waves

- Waves traveling in opposite directions

$$V(x) = V_0^+ e^{\gamma x} + V_0^- e^{-\gamma x}$$

$$I(x) = \frac{V_0^+}{Z_0} e^{\gamma x} - \frac{V_0^-}{Z_0} e^{-\gamma x}$$

- Propagation constant

$$\gamma = \sqrt{(R + j\omega L)(G + j\omega C)} = \alpha + j\beta$$

Phase per unit length



- Characteristic impedance

$$Z_0 = \sqrt{\frac{R + j\omega L}{G + j\omega C}}$$

Attenuation per unit length



Characteristic Impedance Approximations

$$\begin{aligned} Z_0 &= \sqrt{\frac{R + j\omega L}{G + j\omega C}} \\ &= \sqrt{\frac{L}{C}} \times \sqrt{\frac{1 - j\frac{R}{\omega L}}{1 - j\frac{G}{\omega C}}} = Z_{0,\text{infinity}} \times (\text{correction for low frequencies}) \\ &= \sqrt{\frac{R}{G}} \times \sqrt{\frac{1 + j\frac{\omega L}{R}}{1 + j\frac{\omega C}{G}}} = Z_{0,\text{DC}} \times (\text{correction for high frequencies}) \end{aligned}$$

Transmission Line Distributed Parameters from Physical Dimensions and Material Properties

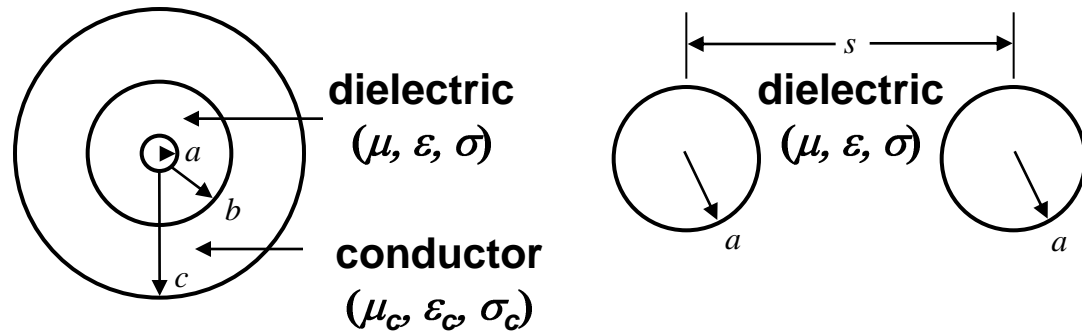

Parameter

$R \ \Omega / \text{m}$	$\frac{1}{2\pi\delta\sigma_c} \left(\frac{1}{a} + \frac{1}{b} \right)$	$\frac{1}{\pi a \delta \sigma_c}$
$L \ \text{H} / \text{m}$	$\frac{\mu}{2\pi} \left[\ln \frac{b}{a} + \frac{\delta}{2} \left(\frac{1}{a} + \frac{1}{b} \right) \right]$	$\frac{\mu}{\pi} \left[\frac{\delta}{2a} + \cosh^{-1} \frac{s}{2a} \right]$
$G \ \text{S} / \text{m}$	$\frac{2\pi\sigma}{\ln \frac{b}{a}}$	$\frac{\pi\sigma}{\cosh^{-1} \frac{s}{2a}}$
$C \ \text{F} / \text{m}$	$\frac{2\pi\epsilon}{\ln \frac{b}{a}}$	$\frac{\pi\epsilon}{\cosh^{-1} \frac{s}{2a}}$
$\delta \ \text{m}$	$\frac{1}{\sqrt{\pi f \mu_c \sigma_c}}$	for copper $\delta_{\text{Copper}} = \begin{cases} 8.5 \text{ mm at } 60 \text{ Hz} \\ 6.6 \ \mu\text{m at } 100 \text{ MHz} \end{cases}$

Round Open-Wire Transmission Line (PEC in Air)

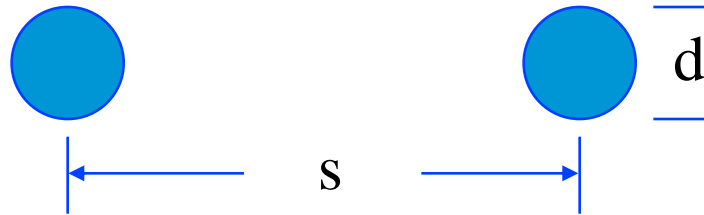

- **Exact characteristic impedance formula assuming $\delta \ll a$**

$$Z_0 = 119.917 \cosh^{-1} \left(\frac{s}{d} \right)$$

- **Approximate, asymptotic formula**

- Accurate only for large spacings: $s/d > 3$
or large impedances: $Z_0 > \text{several hundred}$

$$Z_0 = 120 \ln \left(\frac{2s}{d} \right) = 276 \log_{10} \left(\frac{2s}{d} \right)$$

Characteristic Impedance of Round Open-Wire Line

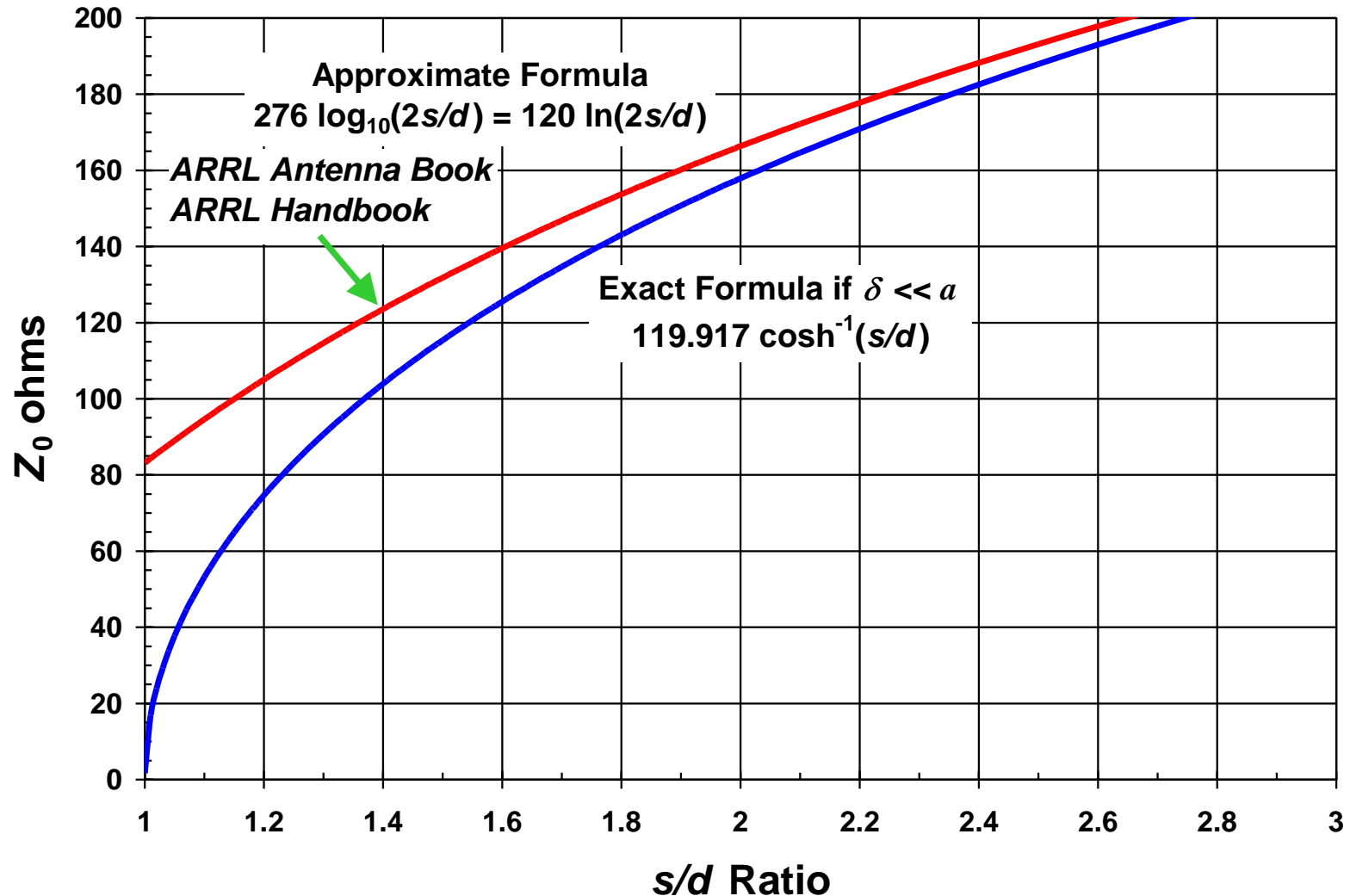

Myths and Bloopers

- **Impedance of round open-wire line in air**

- “ Z_0 approaches 83 ohms as s/d approaches unity.”
George Murphy, VE3ERP, CQ, Nov. 2000

- **Facts**

- For open-wire line, Z_0 approaches zero as s/d approaches unity
- In the limit as the wires touch, the characteristic impedance is that of a short circuit
- The confusion comes from using the asymptotic formula in a region where it is not accurate

Matched Loss of Common Transmission Lines

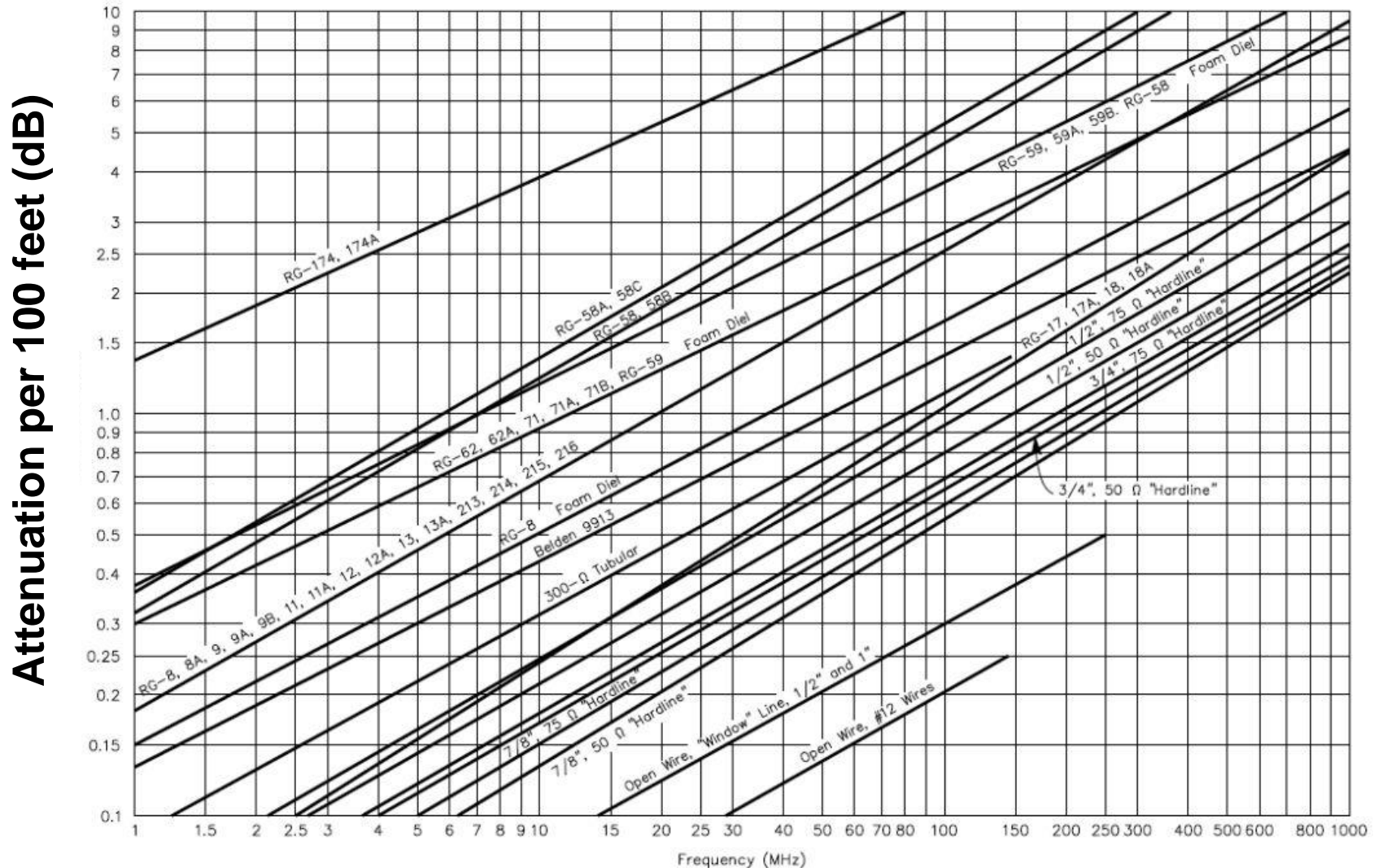

Source: *ARRL Antenna Book*, 21st ed., p. 24-20

Standing-Wave Ratio (SWR)

Question – Do the Meters Read the Same SWR?

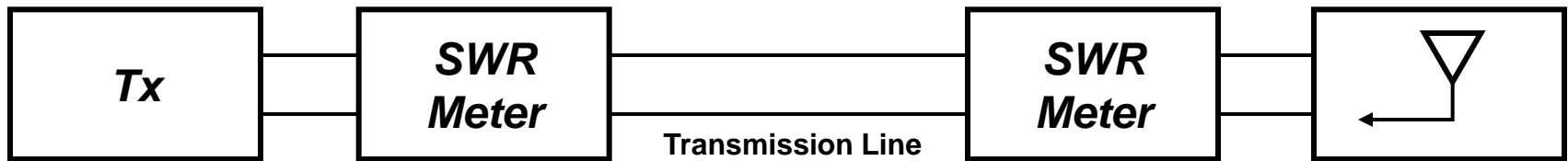

Answer

- **For lossless lines:**

- Forward and reverse wave amplitudes are the same everywhere along the line
- SWR is the same everywhere along the line
- SWR is the ratio of max to min voltage (or current) along the line

- **For lossy lines**

- Forward and reverse wave amplitudes vary along the line
- SWR is maximum at the load and decreases gradually to a minimum at the source
- The “max / min” definition of the lossless case doesn’t work because max and min occur at different locations
- Best definition is

$$SWR = \frac{1 + \sqrt{\frac{P_R}{P_F}}}{1 - \sqrt{\frac{P_R}{P_F}}} = \frac{1 + |\Gamma|}{1 - |\Gamma|}$$

Voltage and Current Standing Waves

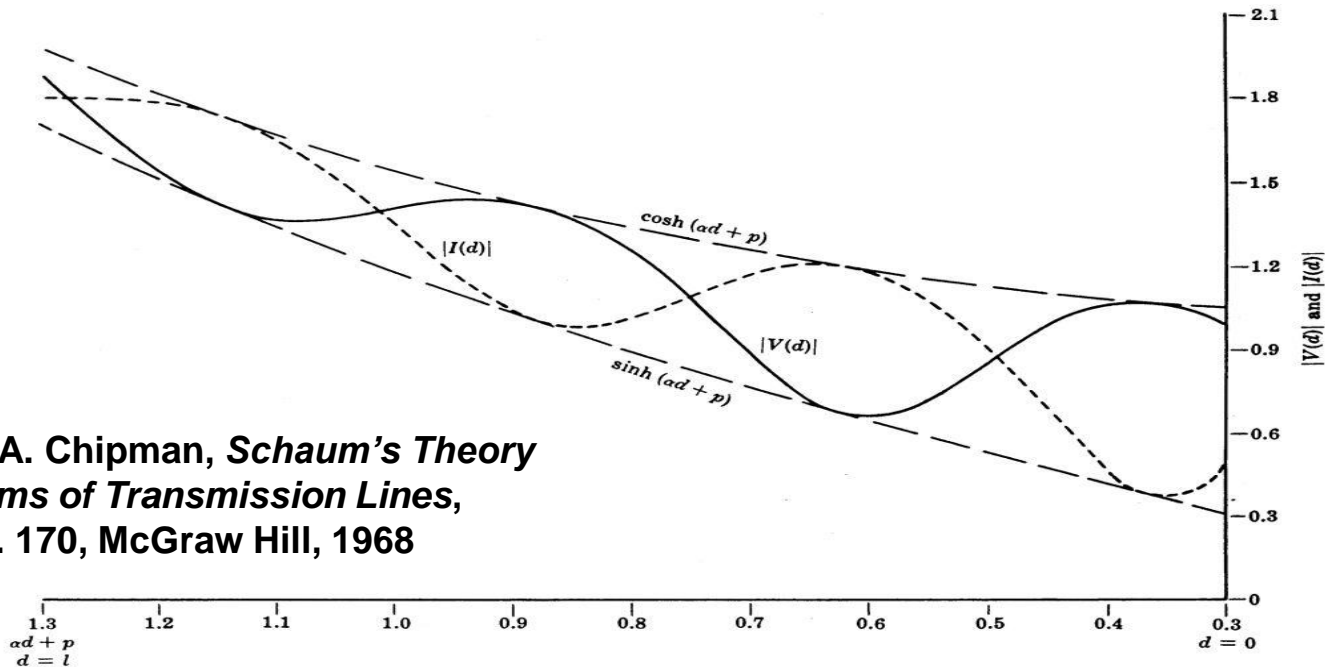

Source: R.A. Chipman, *Schaum's Theory and Problems of Transmission Lines*, Fig. 8-10, p. 170, McGraw Hill, 1968

Impedance and SWR Along a Line

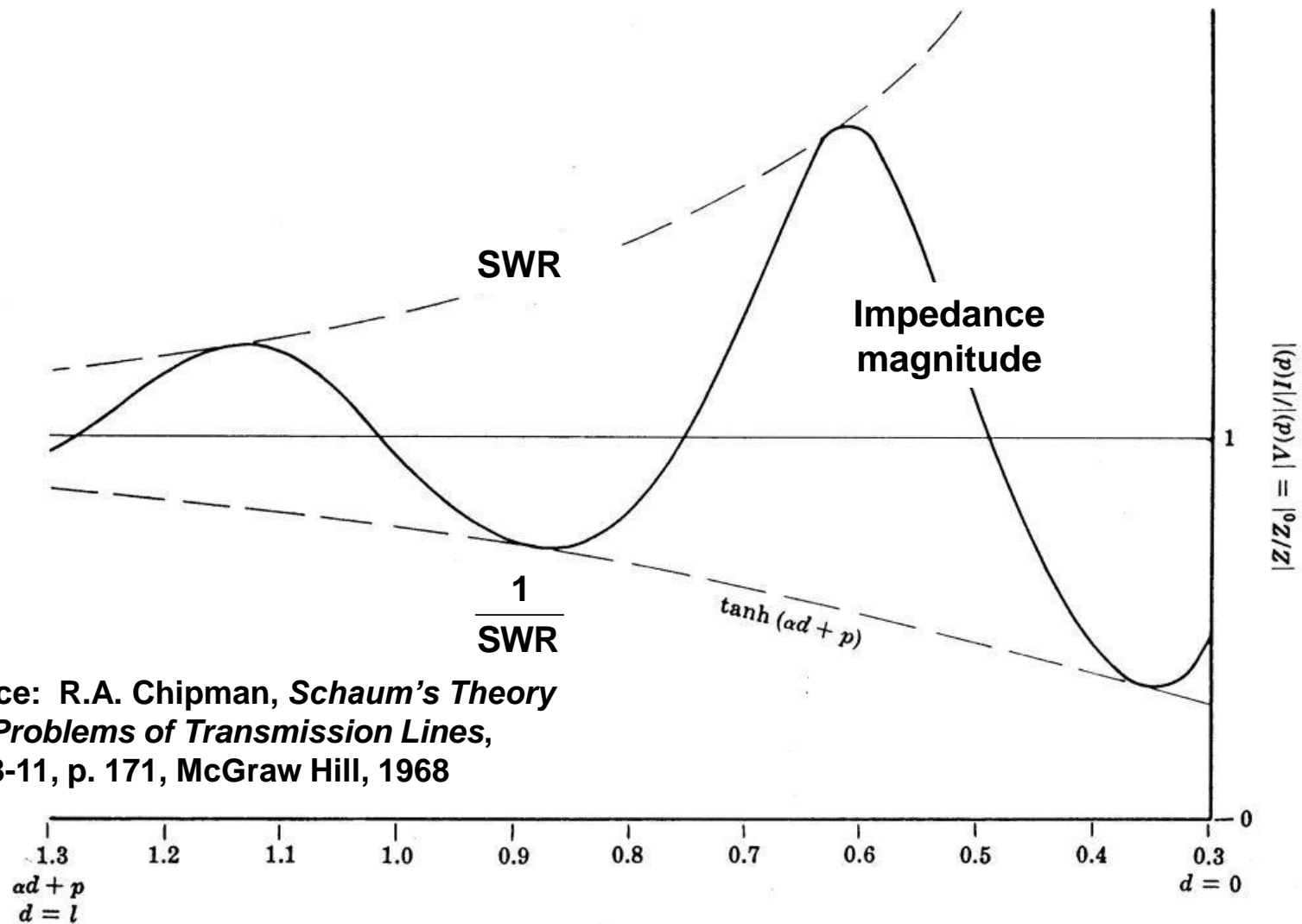

Source: R.A. Chipman, *Schaum's Theory and Problems of Transmission Lines*, Fig. 8-11, p. 171, McGraw Hill, 1968

Standing Wave Ratio at a Resistive Load

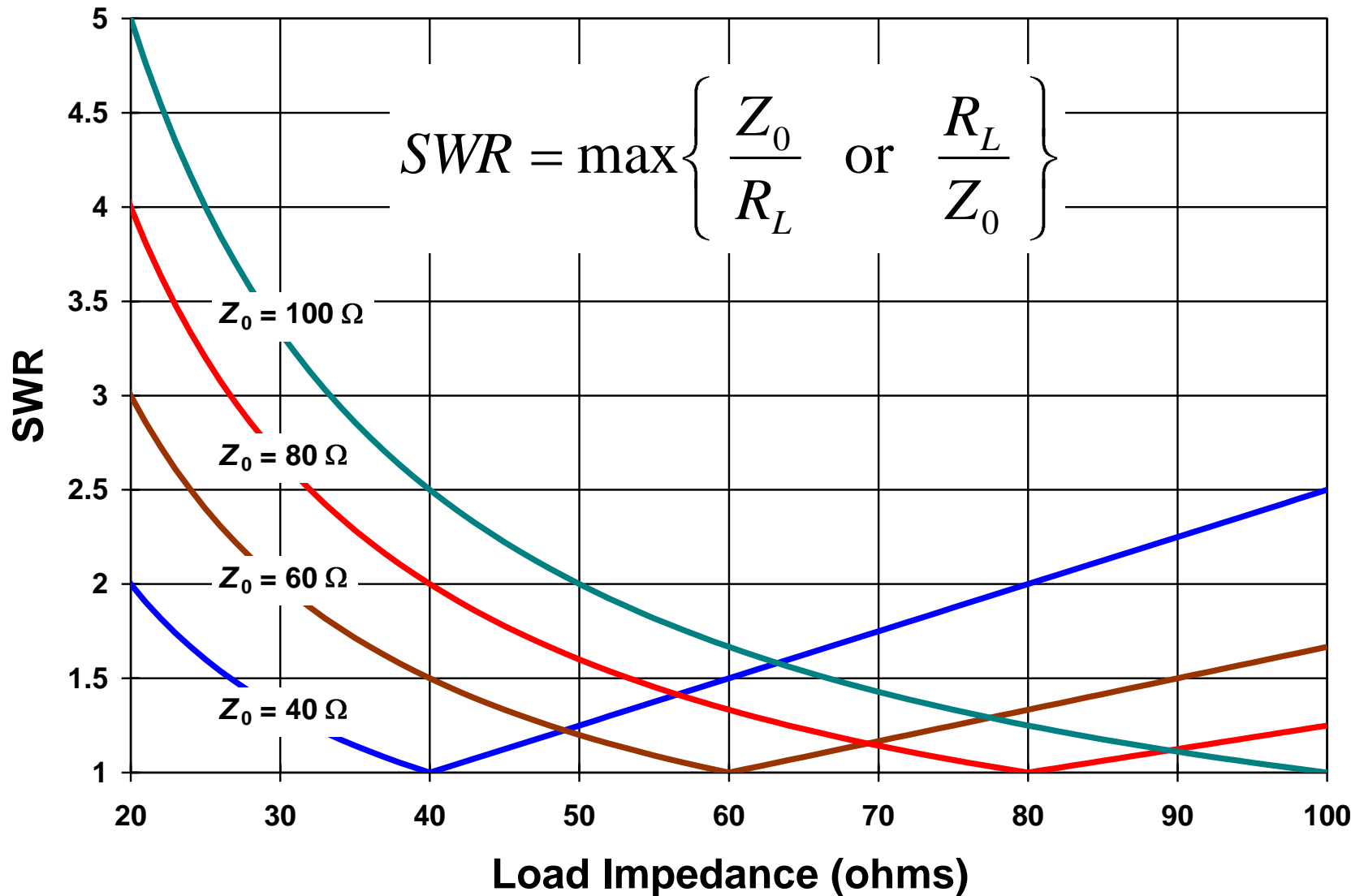

Three Loss Graphs

Graph 1: "Additional Loss Due to SWR"

- Published in every *ARRL Antenna Book* since 1949
- Published in every *ARRL Handbook* since 1986

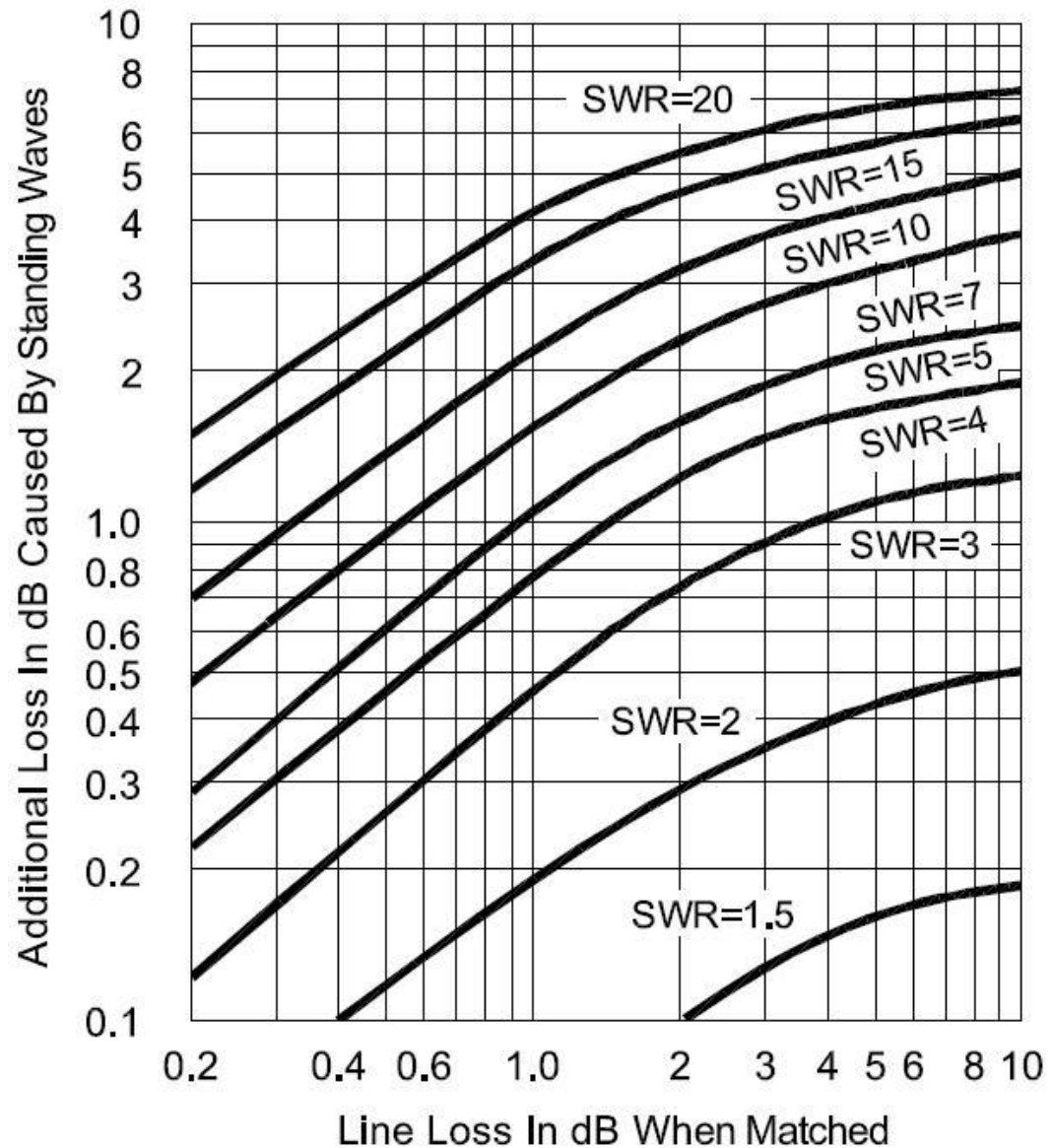

Published in German

- K. Rothammel (Y21BK), *Antennenbuch*, Fig. 5.25, p. 98, 1981

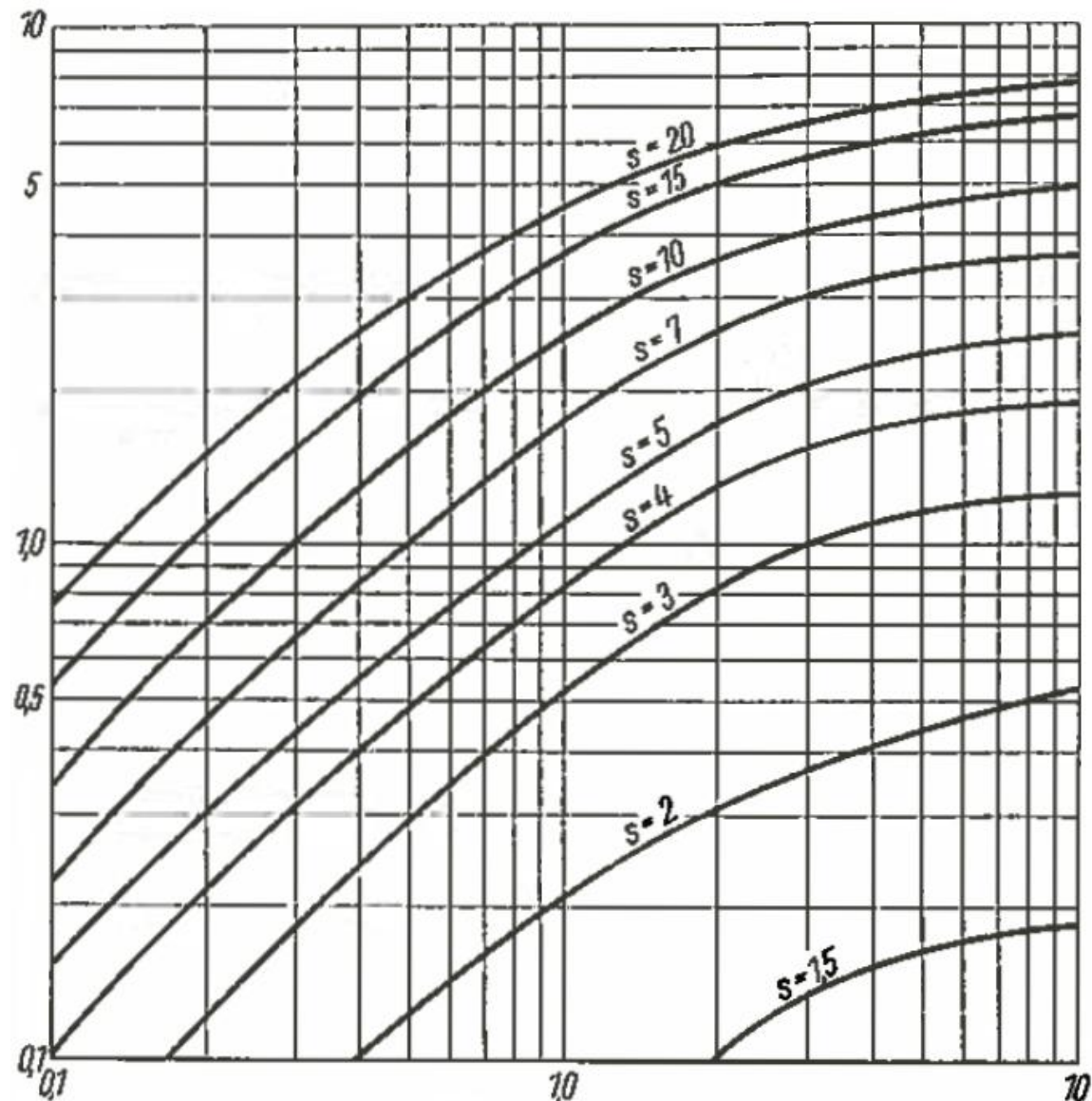

Graph 2: "Total Loss Due to SWR at Load"

- Published in *ARRL Handbook* 1981 through 1984
- But never published in *ARRL Antenna Book*

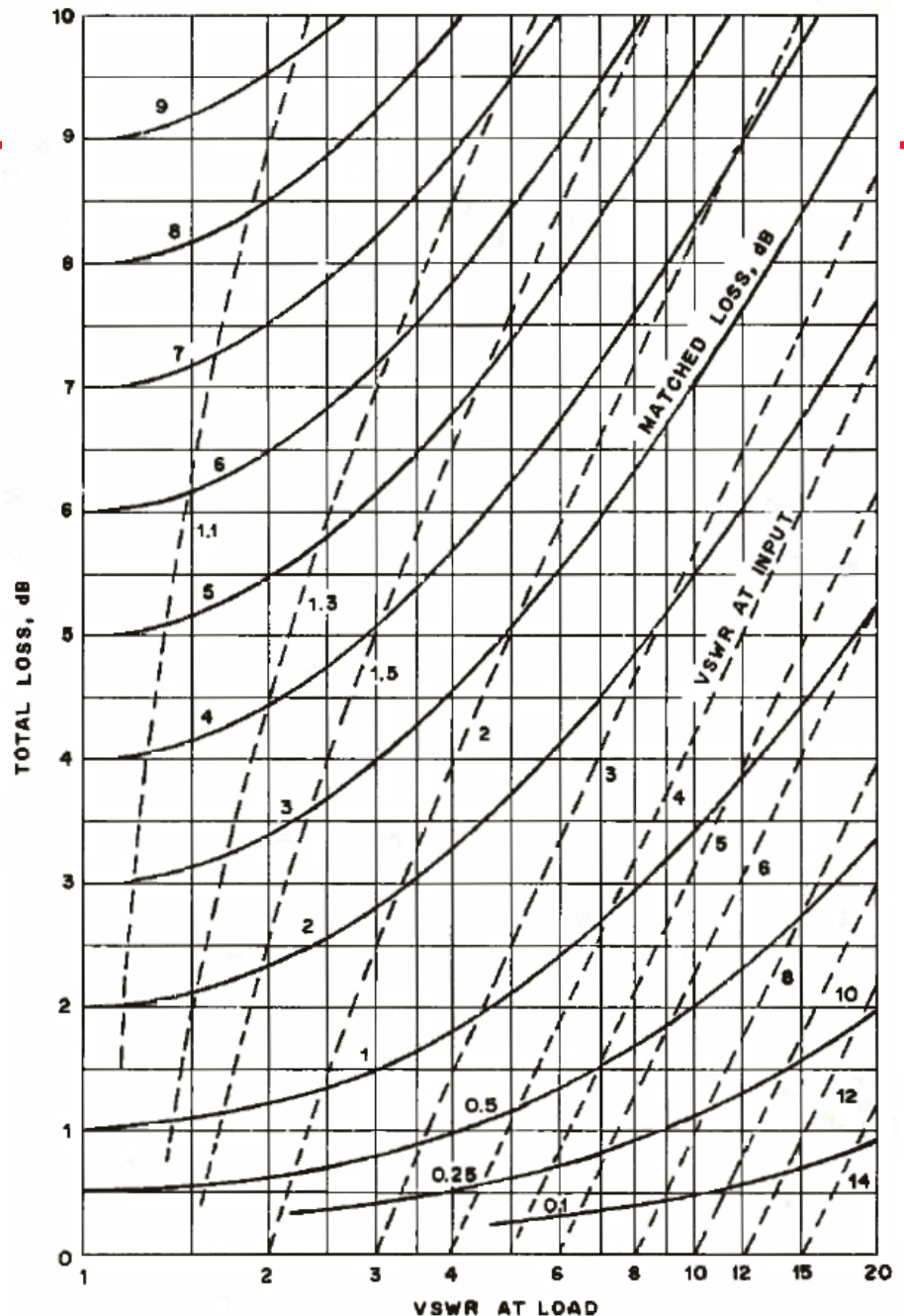

Graph 3: "SWR at Antenna vs SWR at Transmitter"

- Published in ARRL Antenna Book from 1974 or earlier through
- Published in ARRL Handbook from 1985/86 to 1987 or later
- Also K. Rothammel (Y21BK), *Antennenbuch*, Fig. 5.26, p. 99, 1981

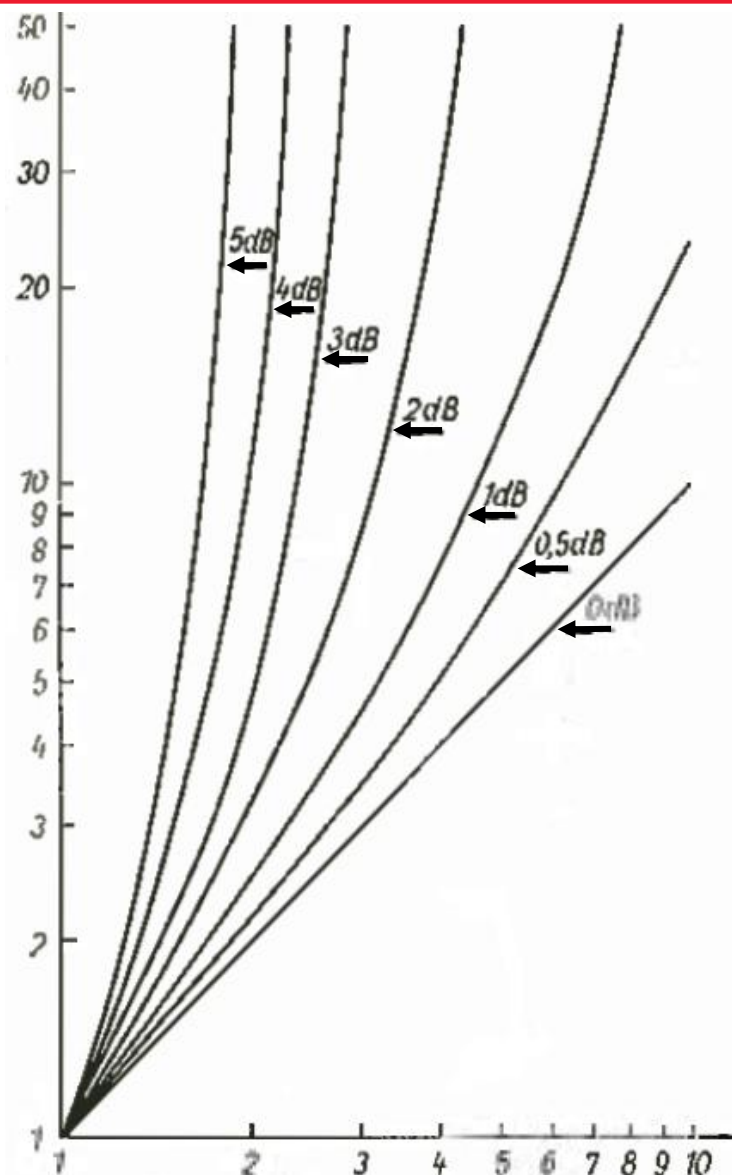

Forward and Reflected Power on a Lossy Line

- Power at load end in terms of power at transmitter end of line

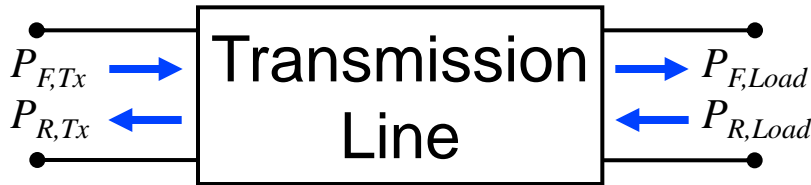

$$P_{F,Load} = \frac{1}{a} \cdot P_{F,Tx}$$

$$P_{R,Load} = a \cdot P_{R,Tx}$$

- a is the power attenuation ratio or matched loss in linear units, a real constant greater than unity, expressible in terms of the line's attenuation constant and scattering parameters as

$$a = \begin{cases} e^{2\alpha l} & \text{for } \alpha \text{ in nepers/meter and } l \text{ in meters} \\ \text{or} \\ 10^{\alpha l / 1000} & \text{for } \alpha \text{ in dB / 100 feet and } l \text{ in feet} \end{cases}$$

Latin a and Greek α
should not be confused

$$a = \frac{1}{|S_{21}|^2}$$

Input & Output Reflection Coefficients and SWRs

- Relation between reflection coefficients at both ends of line

$$|\Gamma_{Load}|^2 = \frac{P_{R,Load}}{P_{F,Load}} = a^2 \frac{P_{R,Tx}}{P_{F,Tx}} = a^2 |\Gamma_{in}|^2$$

- Bound on input reflection coefficient

$$|\Gamma_{Load}| < 1 \Rightarrow |\Gamma_{in}| < \frac{1}{a}$$

- Reflection coefficients in terms of SWRs at both ends of line

$$|\Gamma_{in}| = \frac{SWR_{Tx} - 1}{SWR_{Tx} + 1} \quad \text{and} \quad |\Gamma_{Load}| = \frac{SWR_{Load} - 1}{SWR_{Load} + 1}$$

Input SWR in Terms of SWR at Load

- General relation

$$SWR_{Tx} = \frac{(a+1) SWR_{Load} + (a-1)}{(a-1) SWR_{Load} + (a+1)} = \frac{SWR_{Load} + \left(\frac{a-1}{a+1}\right)}{1 + SWR_{Load} \left(\frac{a-1}{a+1}\right)}$$

- Bound on input SWR

$$1 \leq SWR_{Load} < \infty \quad \Rightarrow \quad 1 \leq SWR_{Tx} < \frac{a+1}{a-1} = \coth \alpha l$$

Maximum Input SWR

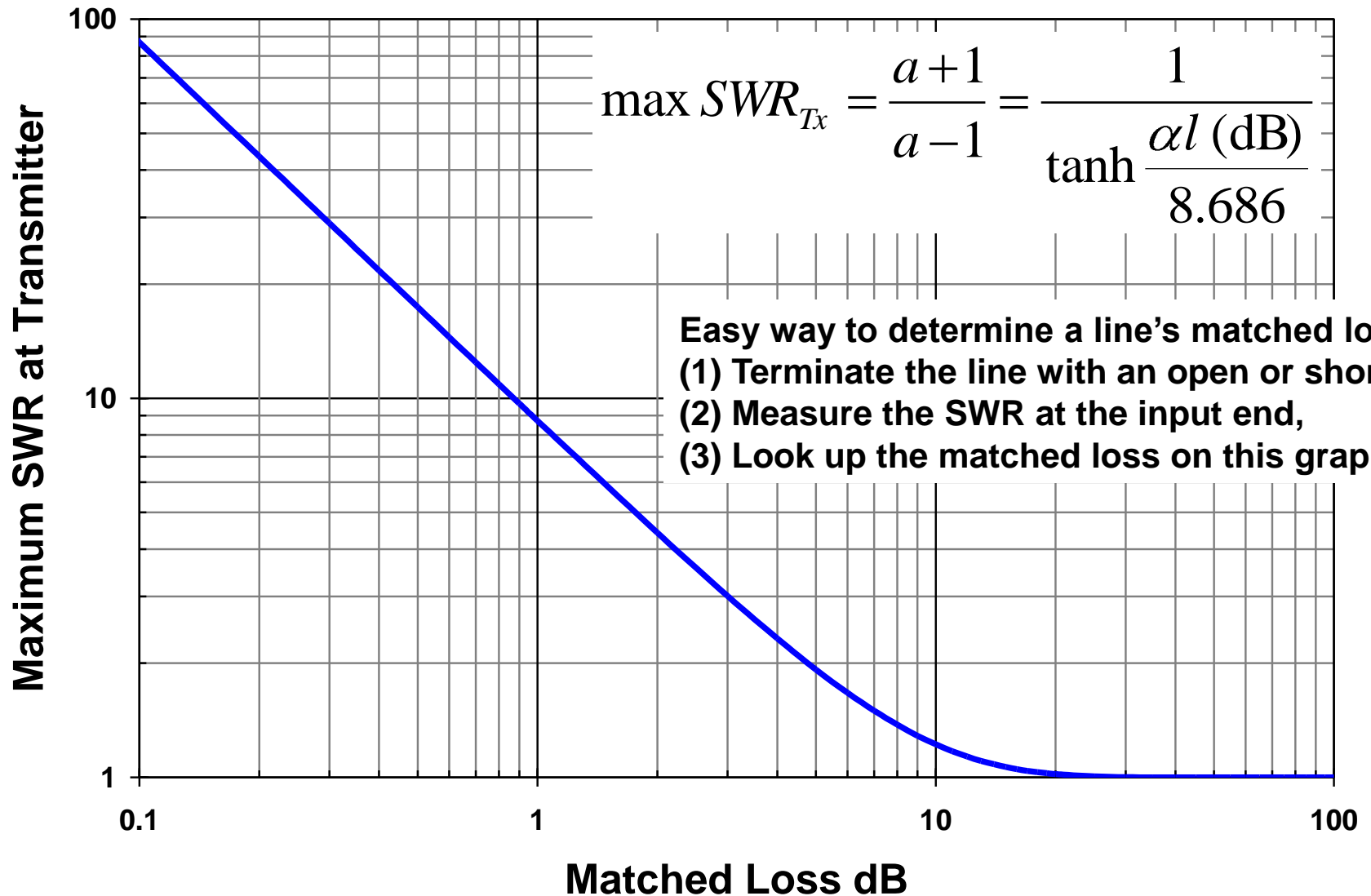

Output SWR at Load in Terms of Input SWR

- General relation

$$SWR_{Load} = \frac{(a+1)SWR_{Tx} - (a-1)}{-(a-1)SWR_{Tx} + (a+1)} = \frac{SWR_{Tx} - \left(\frac{a-1}{a+1}\right)}{1 - SWR_{Tx} \left(\frac{a-1}{a+1}\right)}$$

- For

$$1 \leq SWR_{Tx} \leq \frac{a+1}{a-1} = \coth \alpha l$$

SWR at Antenna versus SWR at Transmitter

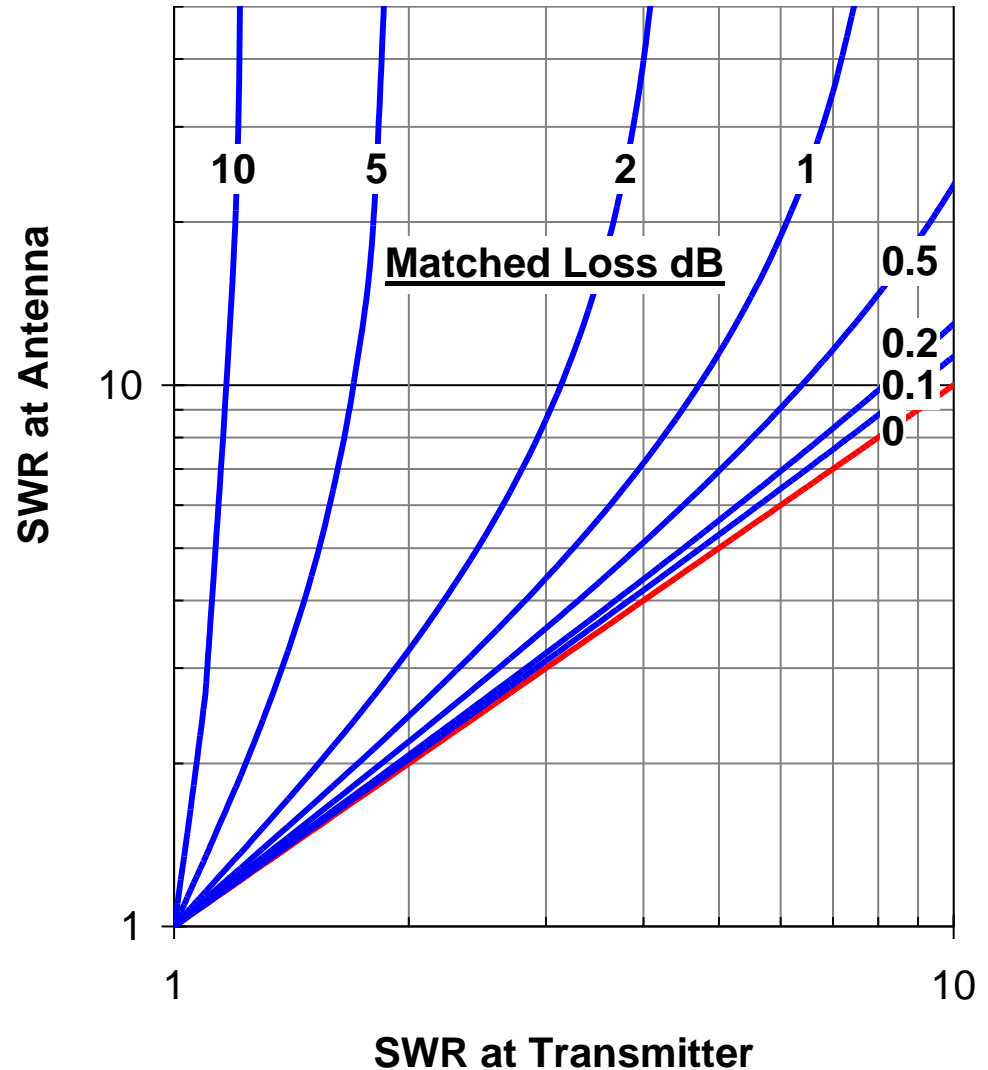
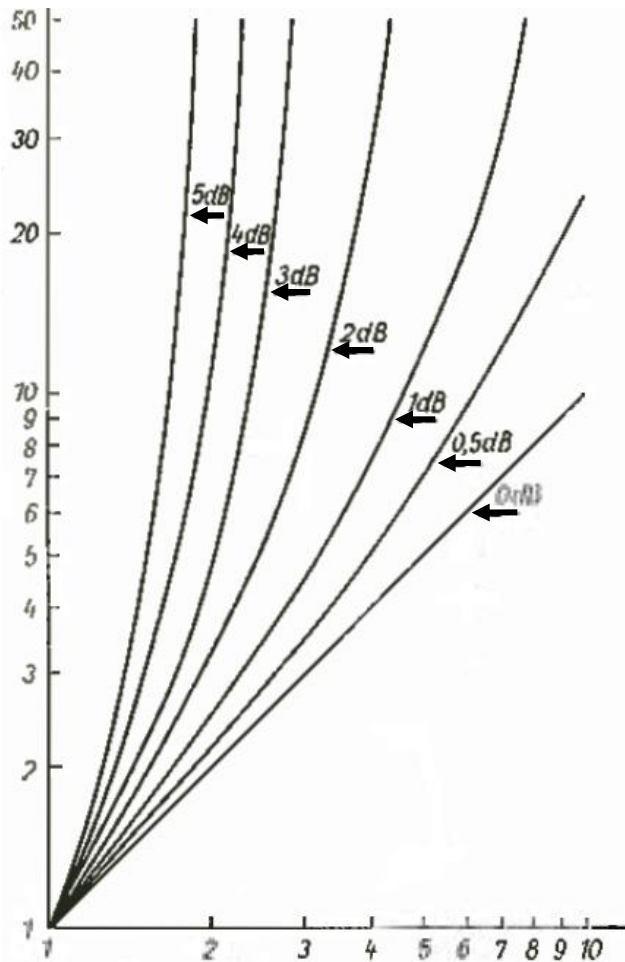

Source: K. Rothammel (Y21BK),
Antennenbuch, Fig. 5.26, p. 99, 1981

Additional SWR at Load Due to Mismatch and Line Loss

- Additional SWR as a difference

$$SWR_{Load} - SWR_{Tx} = \frac{(SWR_{Tx})^2 - 1}{\left(\frac{a+1}{a-1}\right) - SWR_{Tx}}$$

- Additional SWR as a ratio

$$\frac{SWR_{Load}}{SWR_{Tx}} = \frac{1 - \left(\frac{1}{SWR_{Tx}}\right)\left(\frac{a-1}{a+1}\right)}{1 - SWR_{Tx}\left(\frac{a-1}{a+1}\right)}$$

- For

$$1 \leq SWR_{Tx} \leq \frac{a+1}{a-1} = \coth \alpha l$$

Additional SWR at Load Due to SWR

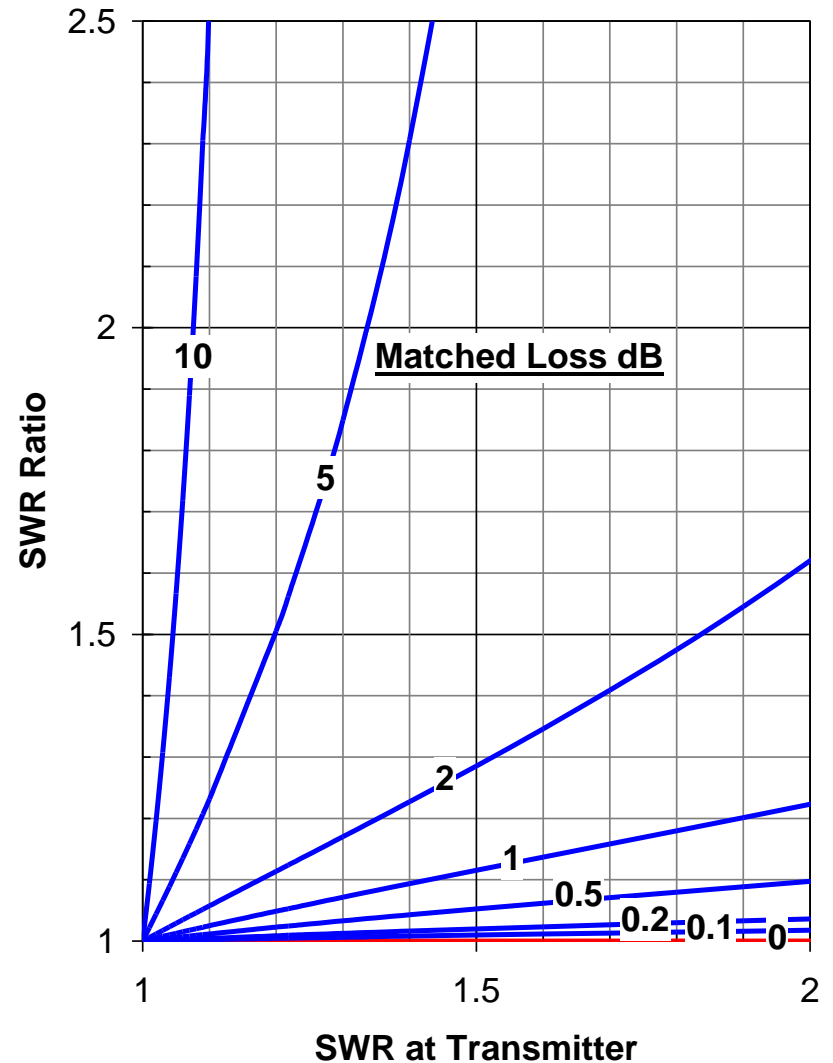
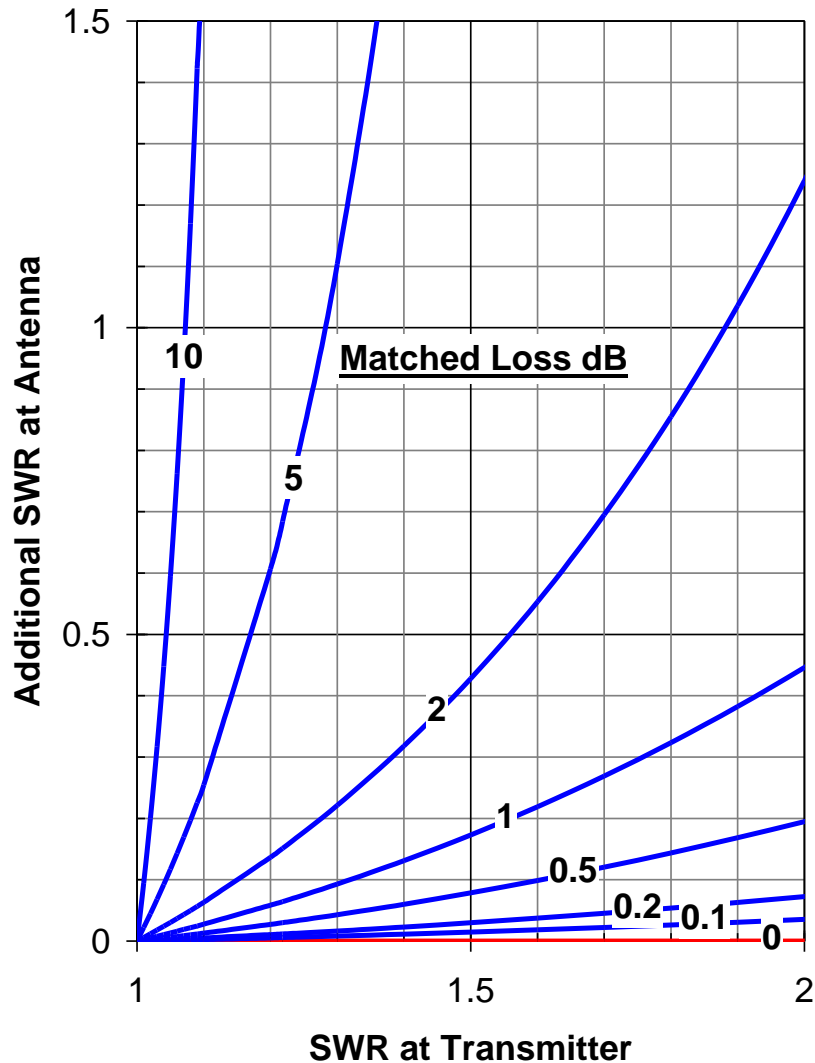

Power Loss

Losses Are Due to Reflection and Dissipation



$$IL_{dB} = ML_{dB} + DL_{dB}$$

Lossless networks

$$DL_{dB} = 0$$

$$IL_{dB} = ML_{dB}$$

Reflectionless networks

$$ML_{dB} = 0$$

$$IL_{dB} = DL_{dB}$$

Reflection Loss of a Terminated Line vs Input SWR

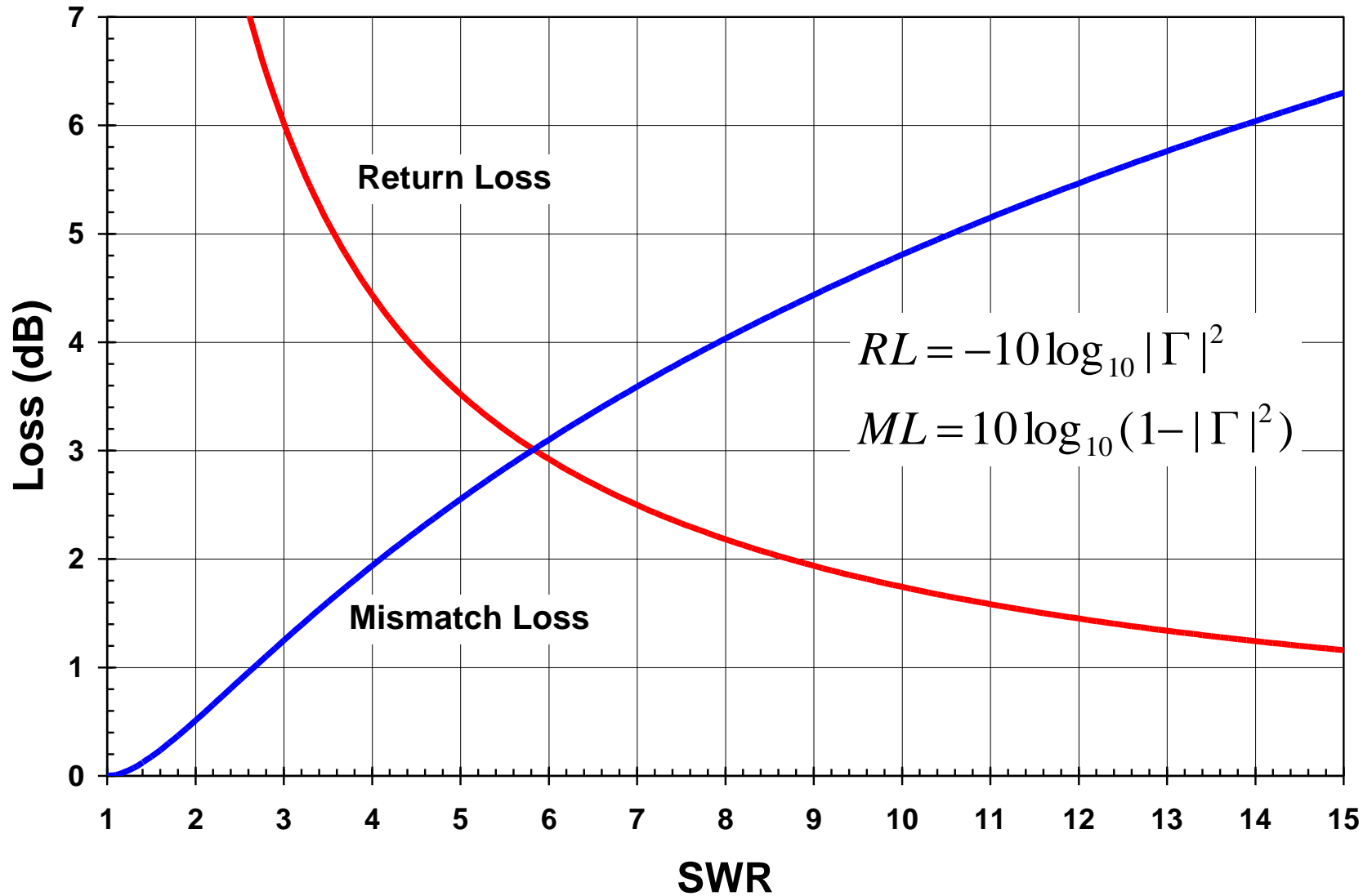

Myths and Bloopers

■ Return loss

- “Return Loss is 20 times the reflection coefficient.”
Kurt N. Sterba, *WorldRadio*, Jan, 2007
- “Return Loss is not a commonly used quantity.”
Brice Wightman, VE3EDR, VA2BW, *WorldRadio*, May 2007
- “Return Loss is 20 times the reciprocal of the reflection coefficient.”
Kurt N. Sterba, *WorldRadio*, June 2007

■ Facts

- Return loss is more common than SWR in professional RF design papers, but its misuse is of concern
 - T.S. Bird, “Definition and Misuse of Return Loss,” *IEEE Antennas and Propagation Magazine*, vol. 51, no. 2, pp. 166-167, Apr. 2009
 - Ed Wetherhold (W3NQN), “Return Loss Definition,” *QST*, vol. 94, no. 9, pp. 45-47, Sept. 2010
 - Gary Breed (K9AY), “Return Loss, Reflection Coefficient and $|S_{11}|$,” *High Frequency Electronics*, vol. 9, no. 9, p. 80, Sept. 2010

Derivation of Transmission Line Total Loss

$$\begin{aligned}
 \text{Total Loss (dB)} &= 10 \log_{10} \frac{P_{in}}{P_{out}} \\
 &= 10 \log_{10} \frac{P_{F,Tx} - P_{R,Tx}}{P_{F,Load} - P_{R,Load}} \\
 &= 10 \log_{10} \left(\frac{P_{F,Tx}}{P_{F,Load}} \right) \left(\frac{1 - \frac{P_{R,Tx}}{P_{F,Tx}}}{1 - \frac{P_{R,Load}}{P_{F,Load}}} \right) \\
 &= 10 \log_{10} a \frac{1 - |\Gamma_{in}|^2}{1 - |\Gamma_{Load}|^2} \\
 &= 10 \log_{10} a + 10 \log_{10} \frac{1 - |\Gamma_{in}|^2}{1 - |\Gamma_{Load}|^2} \\
 &= \alpha l \text{ (dB)} + 10 \log_{10} \frac{1 - |\Gamma_{in}|^2}{1 - |\Gamma_{Load}|^2}
 \end{aligned}$$

Additional Loss Due to SWR at Load or Transmitter

- Additional loss can be expressed either in terms of the line's input or output SWR



$$10 \log_{10} \frac{1 - |\Gamma_{in}|^2}{1 - a^2 |\Gamma_{in}|^2} = 10 \log_{10} \frac{(SWR_{Tx} + 1)^2 - (SWR_{Tx} - 1)^2}{(SWR_{Tx} + 1)^2 - a^2 (SWR_{Tx} - 1)^2}$$

Additional Loss (dB) =



$$10 \log_{10} \frac{1 - \frac{1}{a^2} |\Gamma_{Load}|^2}{1 - |\Gamma_{Load}|^2} = 10 \log_{10} \frac{(SWR_{Load} + 1)^2 - \frac{1}{a^2} (SWR_{Load} - 1)^2}{(SWR_{Load} + 1)^2 - (SWR_{Load} - 1)^2}$$

- The next slides show the loss graph both ways

Additional Loss in Terms of SWR at Load

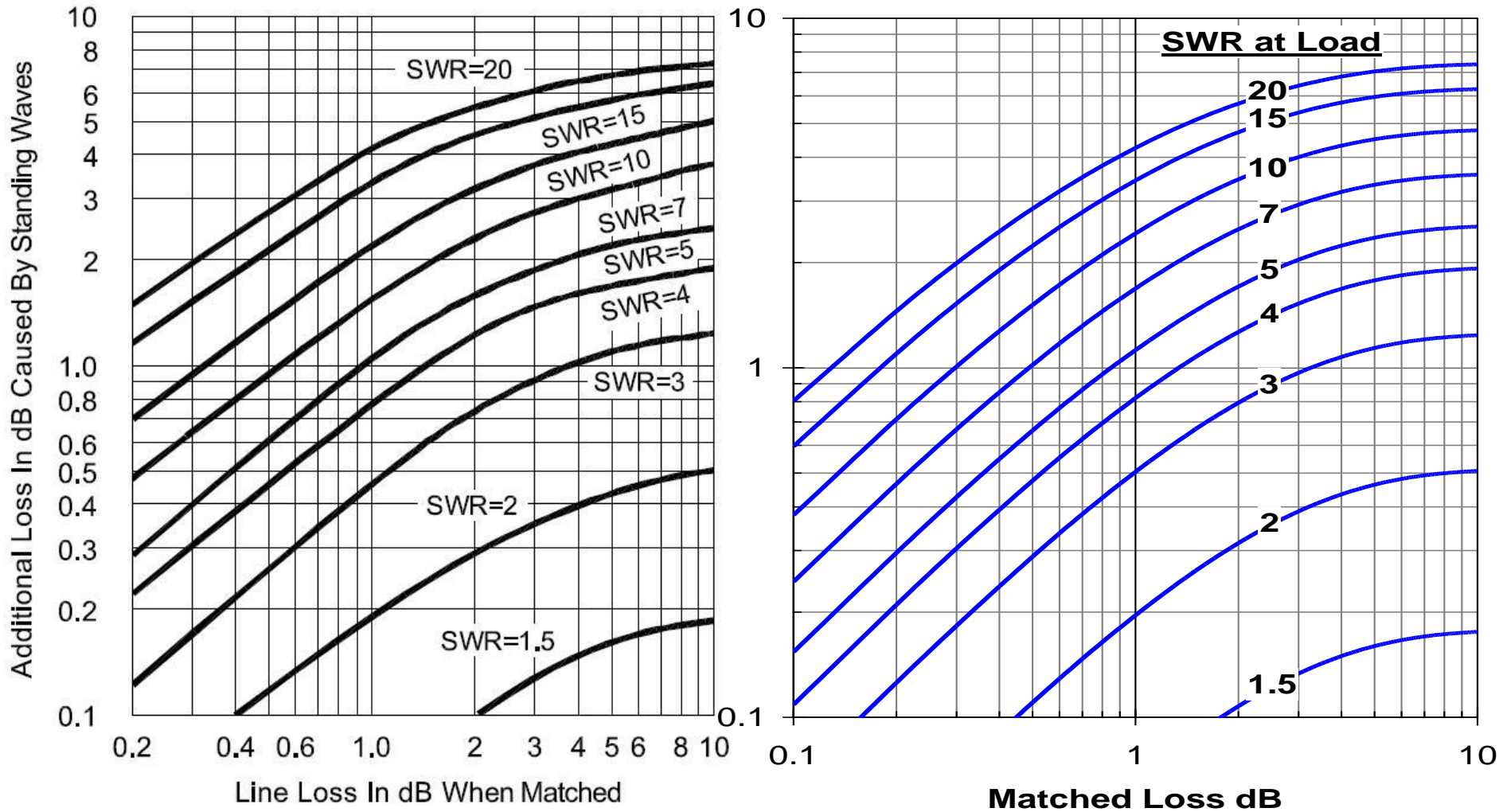

ARRL Handbook, 87th ed., Fig. 20.4, p. 20.5

ARRL Antenna Book, 21st ed., Fig. 14, p. 24-10

Additional Loss in Terms of SWR at Transmitter

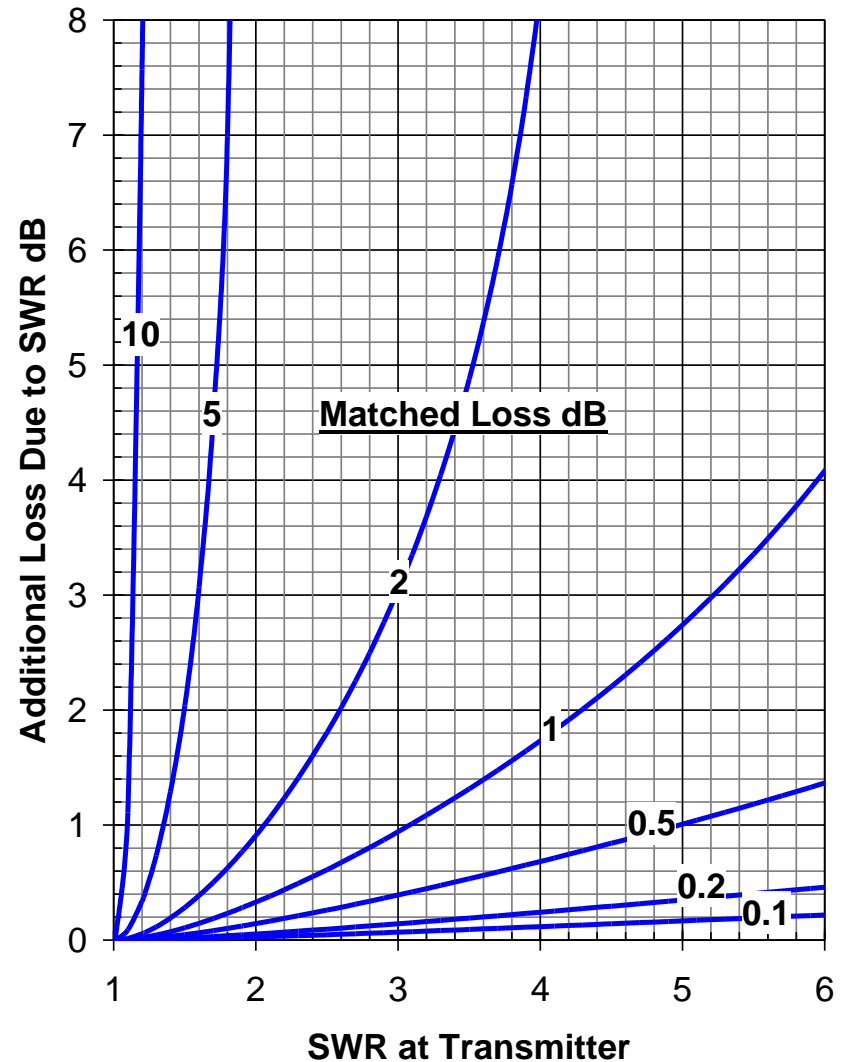
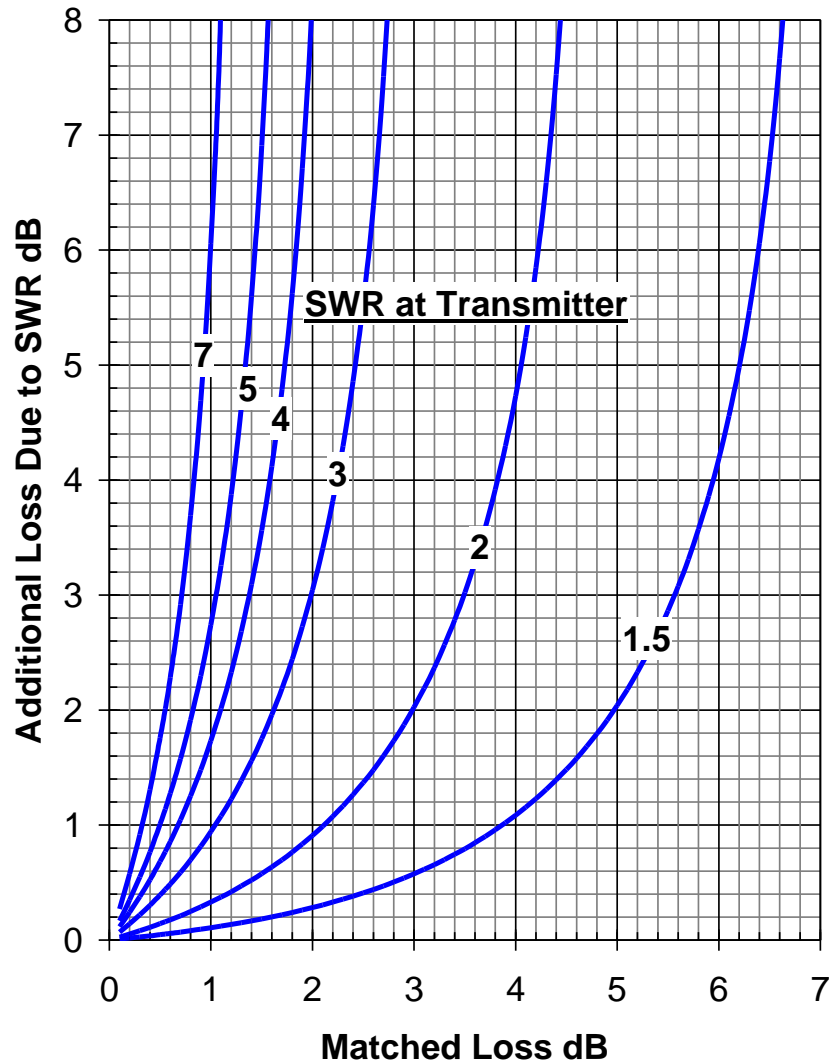

Maximum Power Transfer

With Surprise Ending !

Myths and Bloopers

■ Conjugate match

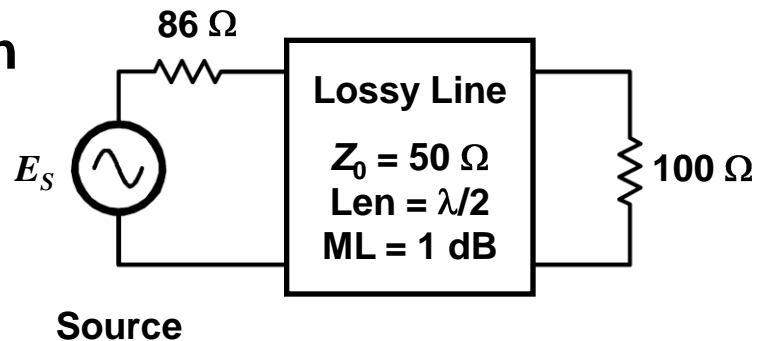

- “Consequently, the source impedance is matched to the input impedance of the line, and the output impedance of the line is matched to its 100-ohm load. ... Thus the output of the line ... is delivering to the load all of the power that is available at the line output. Ergo, there is a conjugate match by definition between the source and the line input and between the output impedance of the line and the load impedance (Axioms 1 and 2) despite the 1.0-dB attenuation in the line.”
Walter Maxwell, W2DU, *Reflections II*, p. A9-8, Worldradio Books, 2001. Also in *Reflections III*, sec. A9A.5, CQ Communications, 2010.

■ Facts

- Circuit analysis reveals that the load is not conjugately matched to the line, only the source is conjugately matched
- A single-end conjugate match (at source or load) does not deliver maximum power to the load if the line is lossy
- Maxwell mistakenly believes otherwise

Analysis

- Determine the Thevenin equivalent source

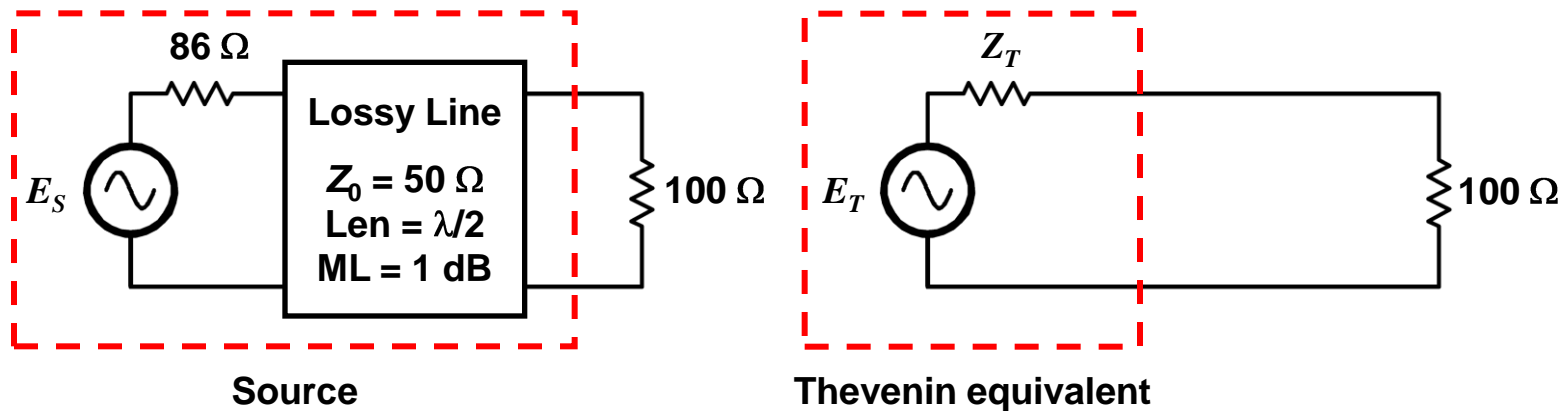

$$E_T = E_{open \ circuit}$$

$$Z_T = \frac{E_{open \ circuit}}{I_{short \ circuit}}$$

Thevenin Equivalent Source

- Thevenin voltage and impedance

$$E_T = E_{open\ circuit} = E_S \left[\frac{1}{\cosh \gamma l} \right] \left[\frac{1}{1 + \frac{Z_S}{Z_0} \tanh \gamma l} \right]$$

$$Z_T = \frac{E_{open\ circuit}}{I_{short\ circuit}} = Z_0 \left[\frac{\frac{Z_S}{Z_0} + \tanh \gamma l}{1 + \frac{Z_S}{Z_0} \tanh \gamma l} \right]$$

$$Z_T = E_S \left[\frac{-1}{\cosh \alpha l} \right] \left[\frac{1}{1 + \frac{86}{50} \tanh \alpha l} \right] = -0.8298 \times E_S$$

$$Z_T = 50 \left[\frac{\frac{86}{50} + \tanh \alpha l}{1 + \frac{86}{50} \tanh \alpha l} \right] = 76.62 \text{ ohms}$$

General equations
Substituting: $\beta l = \pi$ and $\alpha l = 1 \text{ dB}$

- 100 Ω load is not Z_0 matched to 50 Ω nor conjugately matched to 76.6 Ω
- SWR = 2 at load means 0.2 dB of additional, avoidable loss is present
- All available power is NOT delivered to the load

Maximum Power Transfer Theorem

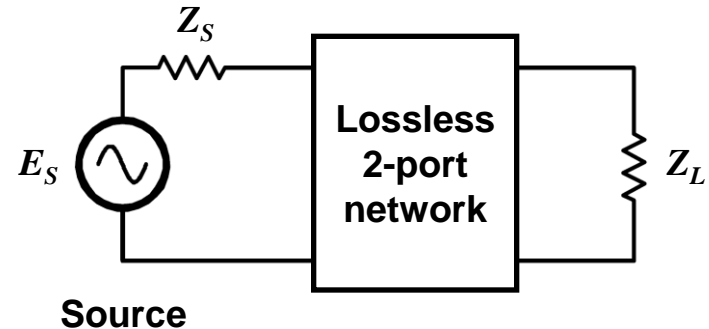
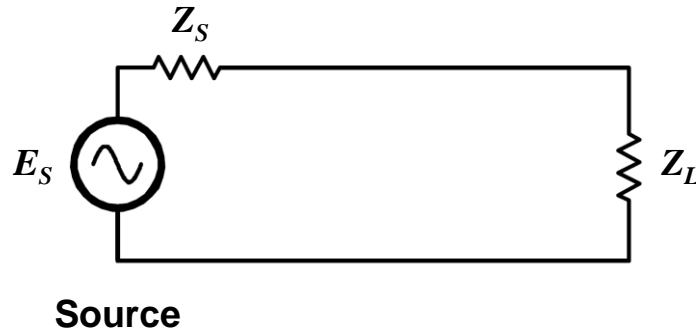

- For a given source, the load impedance that maximizes the power taken from the source is the conjugate of the source impedance
- Note, the theorem does NOT state that if the load impedance is given, then the source impedance that results in maximum power delivery to the load is the conjugate of the load impedance
- However, if a lossless 2-port network is inserted between source and load, then for a given load impedance, the load gets maximum power when the network presents conjugate impedances to the source and load

William Littell Everitt, 1900-1986



Everitt's Conjugate Match Theorem (1932)

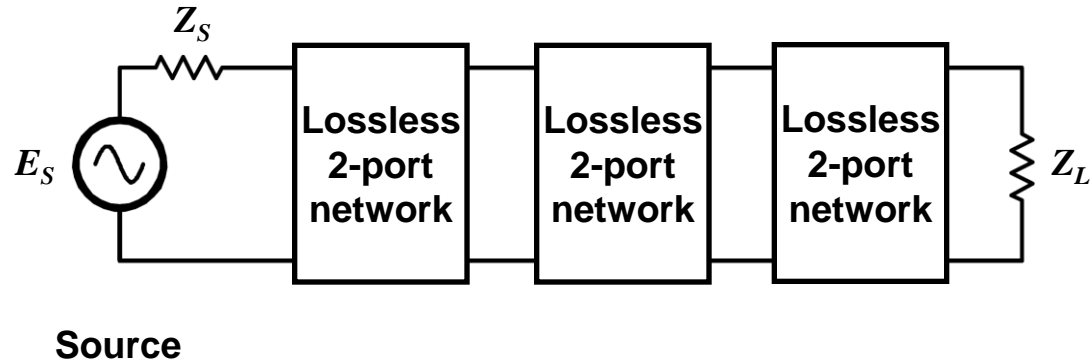

- Consider a series of lossless 2-port networks connected in cascade between a source and a load
- Theorem: If a conjugate match exists at any port in the cascade, then a conjugate match exists at every port in the cascade, including the input and output ports connected to the source and load
- All available power is delivered to the load
- Example: Consider a transmitter, a lossless coupling network, and a transmission line. If the coupling network is conjugately matched, then the transmission line receives all available power from the transmitter

Transmission Line Representations

Z , Y , $ABCD$, and S Parameters



$$\begin{bmatrix} E_1 \\ E_2 \end{bmatrix} = Z_0 \begin{bmatrix} \coth \gamma l & \frac{1}{\sinh \gamma l} \\ \frac{1}{\sinh \gamma l} & \coth \gamma l \end{bmatrix} \begin{bmatrix} I_1 \\ I_2 \end{bmatrix}$$

$$\begin{bmatrix} b_1 \\ b_2 \end{bmatrix} = \begin{bmatrix} 0 & e^{-\gamma l} \\ e^{-\gamma l} & 0 \end{bmatrix} \begin{bmatrix} a_1 \\ a_2 \end{bmatrix}$$

$$\begin{bmatrix} I_1 \\ I_2 \end{bmatrix} = Y_0 \begin{bmatrix} \coth \gamma l & \frac{-1}{\sinh \gamma l} \\ \frac{-1}{\sinh \gamma l} & \coth \gamma l \end{bmatrix} \begin{bmatrix} E_1 \\ E_2 \end{bmatrix}$$

$$\gamma = \alpha + j\beta$$

$$e^{-\gamma l} = e^{-(\alpha l + j\beta l)}$$

$$\begin{bmatrix} E_1 \\ I_1 \end{bmatrix} = \begin{bmatrix} \cosh \gamma l & Z_0 \sinh \gamma l \\ Y_0 \sinh \gamma l & \cosh \gamma l \end{bmatrix} \begin{bmatrix} E_2 \\ -I_2 \end{bmatrix}$$

Important Secondary Parameters of 2-Ports

- Scattering matrix determinant

$$\Delta = \det S = s_{11}s_{22} - s_{12}s_{21}$$

- Rollett's K factor

$$K = \frac{1 - |s_{11}|^2 - |s_{22}|^2 + |\Delta|^2}{2|s_{12}s_{21}|}$$

- Bodway's B factors

$$B_1 = 1 + |s_{11}|^2 - |s_{22}|^2 - |\Delta|^2$$

$$B_2 = 1 - |s_{11}|^2 + |s_{22}|^2 - |\Delta|^2$$

- C factors

$$C_1 = s_{11} - \Delta s_{22}^*$$

$$C_2 = s_{22} - \Delta s_{11}^*$$

For lossy lines

$$\Delta = -e^{-2(\alpha l + j\beta l)}$$

$$|\Delta| = e^{-2\alpha l} < 1$$

$$K = \cosh \alpha l > 1$$

$$B_1 = 1 - e^{-4\alpha l} > 0$$

$$B_2 = 1 - e^{-4\alpha l} > 0$$

$$C_1 = 0$$

$$C_2 = 0$$

Transducer Power Gain

- Maximum power delivery from a given source through a general 2-port to a load is achieved by maximizing “Transducer Power Gain”

$$G_T = \frac{\text{Power delivered to load}}{\text{Power available from source}}$$
$$= \frac{(1 - |\Gamma_S|^2) |s_{21}|^2 (1 - |\Gamma_L|^2)}{|(1 - s_{11}\Gamma_S)(1 - s_{22}\Gamma_L) - s_{12}s_{21}\Gamma_L\Gamma_S|^2}$$

- For a lossy transmission line

$$G_T = \frac{(1 - |\Gamma_S|^2) e^{-2\alpha l} (1 - |\Gamma_L|^2)}{|1 - e^{-2(\alpha l + j\beta l)} \Gamma_L \Gamma_S|^2}$$

Maximum Transducer Power Gain

- Question: For a given 2-port network, what is the maximum transducer gain G_T relative to all source and load impedances?

$$\begin{aligned} G_{MAX} &= \max_{|\Gamma_S| \text{ and } |\Gamma_L|} G_T \\ &= \frac{|S_{21}|}{|S_{12}|} [K - \sqrt{K^2 - 1}] \end{aligned}$$

- For transmission line

$$G_{MAX} = e^{-\alpha l} = \frac{1}{a} = \text{matched loss}$$

- How do we get this maximum gain (minimum loss)?

Shepard Roberts

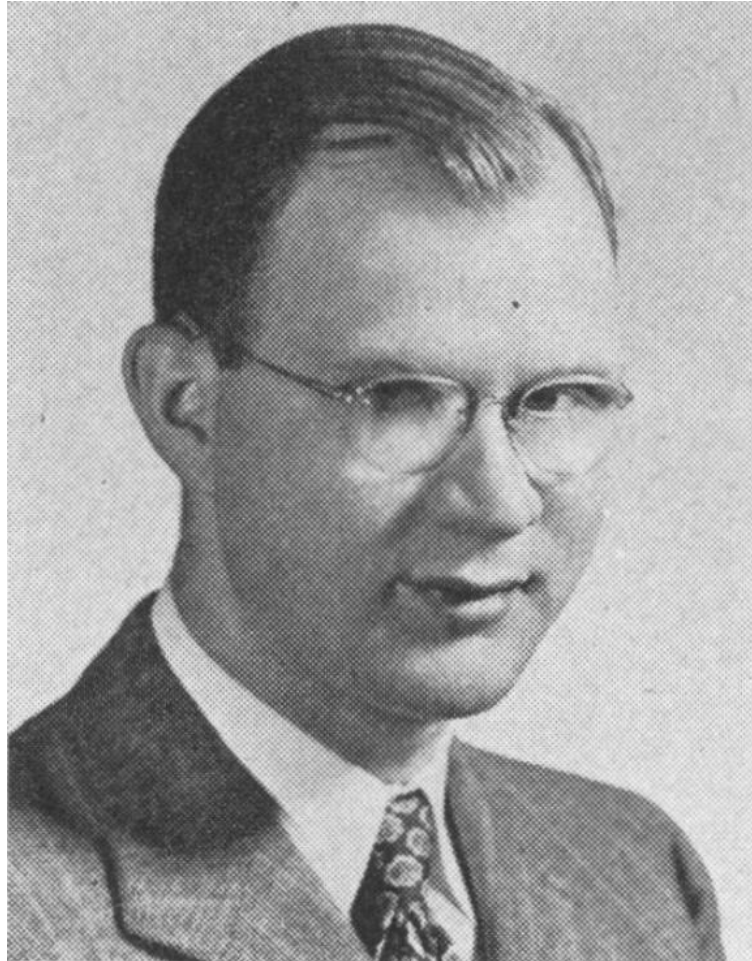

Simultaneous Equations for Maximum Power Transfer

- First solved in terms of Y and Z parameters by S. Roberts (1946)

$$\Gamma_S^* = \Gamma_{in} = s_{11} + \frac{s_{12}s_{21}\Gamma_L}{1 - s_{22}\Gamma_L} = \frac{s_{11} - \Delta\Gamma_L}{1 - s_{22}\Gamma_L}$$

$$\Gamma_L^* = \Gamma_{out} = s_{22} + \frac{s_{12}s_{21}\Gamma_S}{1 - s_{11}\Gamma_S} = \frac{s_{22} - \Delta\Gamma_S}{1 - s_{11}\Gamma_S}$$

$$\Gamma_S^* = e^{-2(\alpha l + j\beta l)} \Gamma_L$$

$$\Gamma_L^* = e^{-2(\alpha l + j\beta l)} \Gamma_S$$

Simultaneous Conjugate Match Equations

Lossy Transmission Line

- Solution in terms of S parameters is in modern books on amplifier design

- G.D. Vendelin, 1982
- C. Bowick, 1982
- R.E. Collin, 1992
- W. Hayward, 1994
- G. Gonzalez, 1997
- D.M. Pozar, 1999
- R. Ludwig and P. Brecht, 2000

The Solution for Maximum Power Transfer

- **Solution for transmission line is evident by inspection**

$$\Gamma_S^* = e^{-2(\alpha l + j\beta l)} \Gamma_L \Rightarrow |\Gamma_S| = e^{-2\alpha l} |\Gamma_L| \Rightarrow |\Gamma_S| \leq |\Gamma_L|$$

$$\Gamma_L^* = e^{-2(\alpha l + j\beta l)} \Gamma_S \Rightarrow |\Gamma_L| = e^{-2\alpha l} |\Gamma_S| \Rightarrow |\Gamma_L| \leq |\Gamma_S|$$

- **Unique solution**

$$\Gamma_S = \Gamma_L = 0$$

- **The solution specifies a pair of lossless match networks at both transmission line ports**
- **Together, the networks give a “simultaneous conjugate match”**
- **But, they do this by implementing double Z_0 matches**
 - Input network transforms source impedance to Z_0
 - Output network transforms load impedance to Z_0

Maximum Power Transfer Through a 2-Port

- General case

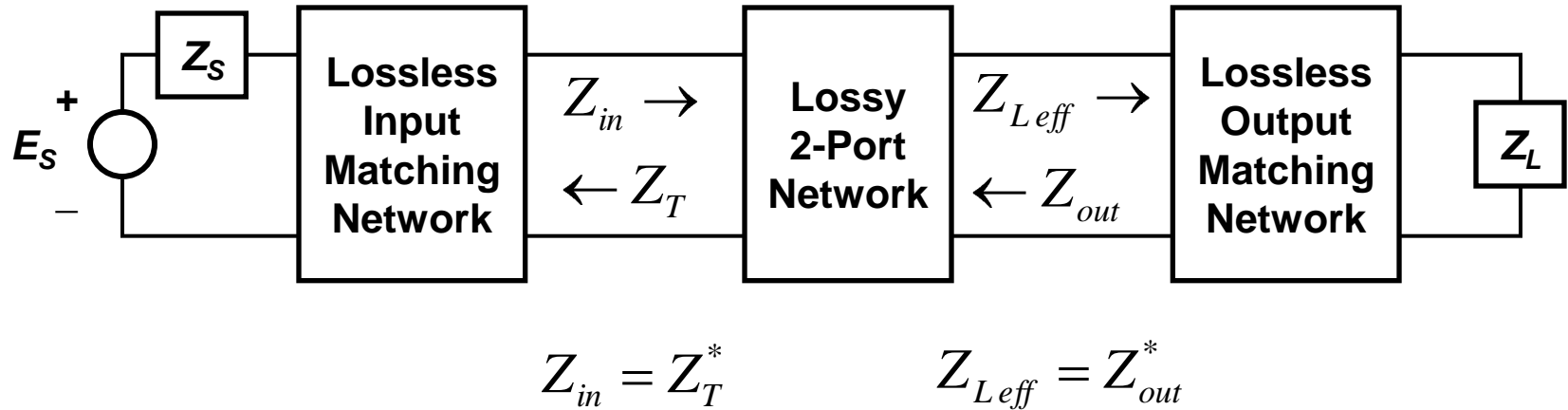

- If the 2-port is a transmission line then the general solution requires that

$$Z_T = Z_{in} = Z_{out} = Z_{Leff} = Z_0$$

Comments

- **Power transfer to a load through a lossy line is maximized by simultaneous conjugate matching at both ends**
 - Maximizes “transducer power gain” of the transmission line
 - Technique is well known in solid-state RF amplifier design
- **The max power solution specifies a pair of networks at both transmission line ports**
 - Input network transforms source impedance to Z_0
 - Output network transforms load impedance to Z_0
- **The solution is NOT a single-ended conjugate match at source or load!**
- **The max power output network at the load is a Z_0 match**
 - SWR on the line is unity, no reflected wave, no additional loss
- **This half of the solution should be used**
- **The input network should not be used with a solid-state amplifier unless the amplifier is unconditionally stable as it can move the load impedance on the transistors outside the stable region of operation**

Comments on the Single-End Conjugate Match

- **The Maximum Power Transfer Theorem is about power delivery to 1-port impedances, not about power delivery through 2-port devices**
- **Single-end conjugate matching at either end of a general lossy line does NOT maximize power transfer from source to load in general**
 - **Does NOT give maximum power transfer from source to load through an intervening 2-port, e.g. a line, except in special cases**
 - **A conjugate match at the input does NOT imply a conjugate match at the output (load) and vice versa, except in special cases**
- **Conjugate matching at the load permits reflected waves on the line**
 - **Total loss = Matched loss + Additional loss due to SWR**
 - **Line becomes a low pass filter: bandwidth decreases with line length and SWR**
- **Conjugate matching at the source permits reflected waves on the line and can damage solid-state amplifiers**
 - **Conjugate match network between amplifier and transmission line interferes with the amplifier's coupling network and can make the amplifier unstable unless the transistors are "unconditionally" stable**
 - **Transistor gain can be unwittingly altered to exceed maximum stable gain (MSG) – refer to stability circles on Smith chart**

Circuit Design Software for Radio Amateurs

- Transmission line loss characterization at single frequency
 - *TLDetails* by Dan Maguire (AC6LA), <http://www.ac6la.com>
 - *TLW 3.0* by Dean Straw (N6BV), 2006, on *Antenna Book CD*
 - *Attenuation and Power Handling Calculator*, Times Microwave Systems http://www.timesmicrowave.com/cable_calculators
- Match network design with frequency sweep and Smith chart display
 - *winSMITH 2.0*, Noble / SciTech Publishing, 1998
 - *Smith 3.10* by Fritz Dellsperger (HB9AJY), 2010, <http://www.fritz.dellsperger.net>
 - *QuickSmith 4.5* by Nathan Iyer (KJ6FOJ), 2009, <http://www.nathaniyer.com>
 - *XLZIZL* by Dan Maguire (AC6LA), <http://www.ac6la.com>
- Full-featured RF circuit design and optimization
 - *Microwave Office 9.03*, Applied Wave Research, 2010, free trial, <http://web.awrcorp.com>
 - *Ansoft Designer SV* (student version), Ansoft, 2005, free, <http://www.rfglobalnet.com> and other web sites
 - *Ansoft Serenade SV* (student version), Ansoft, 2000, free
 - *ARRL Radio Designer 1.5*, ARRL, 1995

References

■ Maximum power transfer

- W.L. Everitt, *Communication Engineering*, 2nd ed., McGraw-Hill, 1937
- S. Roberts, "Conjugate-Image Impedances," *Proc. IRE*, April 1946

■ Amplifier design

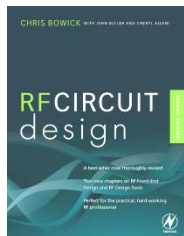

- C. Bowick, *RF Circuit Design*, 2nd ed., pp. 128-131, Newnes, 2007, ISBN 0750685182
- R. Ludwig and P. Brecht, *RF Circuit Design: Theory and Applications*, pp. 492-495, Prentice-Hall, 2000
- D.M. Pozar, *Microwave Engineering*, 2nd ed., pp. 618-621, Wiley 1999
- G. Gonzalez, *Microwave Transistor Amplifiers: Analysis and Design*, 2nd ed., pp. 240-252, 466-468, Prentice-Hall, 1997, ISBN 0132543354
- W. Hayward, W7ZOI, *Introduction to Radio Frequency Design*, pp. 196-197, ARRL, 1994, ISBN 0872594920
- R.E. Collin, *Foundation for Microwave Engineering*, 2nd ed., pp. 730-733, Wiley, 1992
- G.D. Vendelin, *Design of Amplifiers and Oscillators by the S-Parameter Method*, pp. 24-26, Wiley 1982

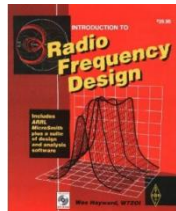
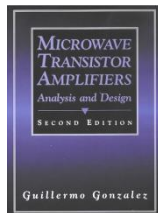

Favorite Antenna Books

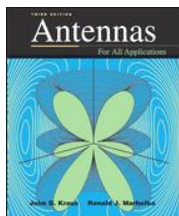
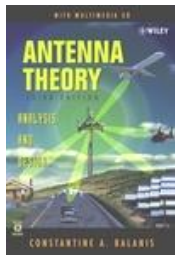
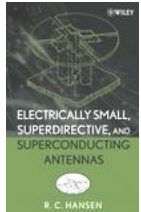
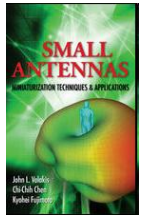

■ Books for antenna engineers and students

- J.L. Volakis et al., *Small Antennas*, McGraw-Hill, 2010, ISBN 0071625534
- *Antenna Engineering Handbook*, 4th ed., J.L. Volakis editor, McGraw-Hill, 2007, ISBN 0071475745. First published in 1961, Henry Jasik editor
- R.C. Hansen, *Electrically Small, Superdirective, and Superconducting Antennas*, Wiley, 2006, ISBN 0471782556
- C.A. Balanis, *Antenna Theory*, 3rd ed., Wiley, 2005, ISBN 047166782X. First published in 1982 by Harper & Row
- J.D. Kraus and R.J. Marhefka, *Antennas*, 3rd ed., McGraw-Hill, 2001, ISBN 0072321032. First published in 1950
- S.J. Orfanidis, *Electromagnetic Waves and Antennas*, draft textbook online at <http://www.ece.rutgers.edu/~orfanidi/ewa/>
- E.A. Laport, *Radio Antenna Engineering*, McGraw-Hill, 1952 <http://snulbug.mtview.ca.us/books/RadioAntennaEngineering>
- G.V. Ayzenberg, *Shortwave Antennas*, 1962, transl. from Russian, DTIC AD0706545

■ Antenna research papers

- IEEE AP-S Digital Archive, 2001-2009 (1 DVD), JD0307
- IEEE AP-S Digital Archive, 2001-2006 (1 DVD), JD0304
- IEEE AP-S Digital Archive, 2001-2003 (1 DVD), JD0301
- IEEE AP-S Digital Archive, 1952-2000 (2 DVDs), JD0351

Favorite Antenna Books continued

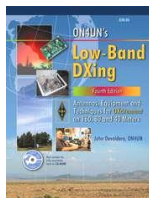
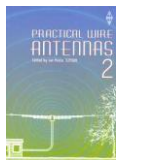
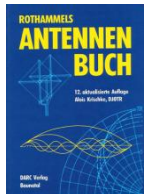
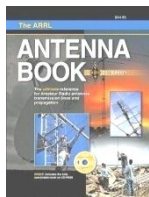

Books for radio amateurs

- *ARRL Antenna Book*, 21st ed., D. Straw (N6BV) editor, American Radio Relay League, 2007, ISBN 0872599876
- *Rothammel's Antennenbuch*, 12th ed., A. Krischke (DJ0TR) editor, DARC Verlag, 2006, ISBN 388692033X
- *Practical Wire Antennas 2*, I. Poole (G3YWX) editor, Radio Society of Great Britain, 2005, ISBN 1905086040
- J. Devoldere (ON4UN), *ON4UN's Low-Band Dxing*, 4th ed., American Radio Relay League, 2005, ISBN 0872599140
- J. Sevick (W2FMI), *The Short Vertical Antenna and Ground Radial*, CQ Communications, 2003, ISBN 0943016223
- L. Moxon (G6XN), *HF Antennas for All Locations*, 2nd ed., Radio Society of Great Britain, 1983, ISBN 1872309151

ARRL Antenna Compendium series – Volumes 1 through 7

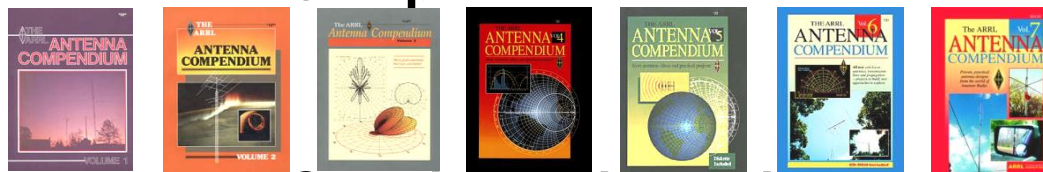

ARRL Antenna Classics series – six titles

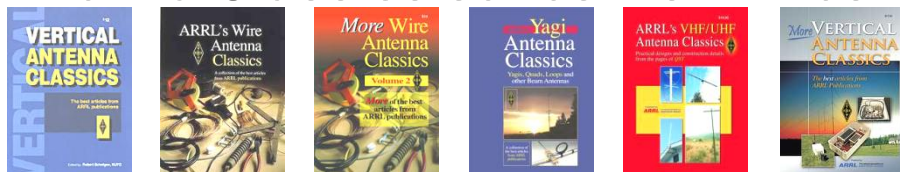

Good Reading

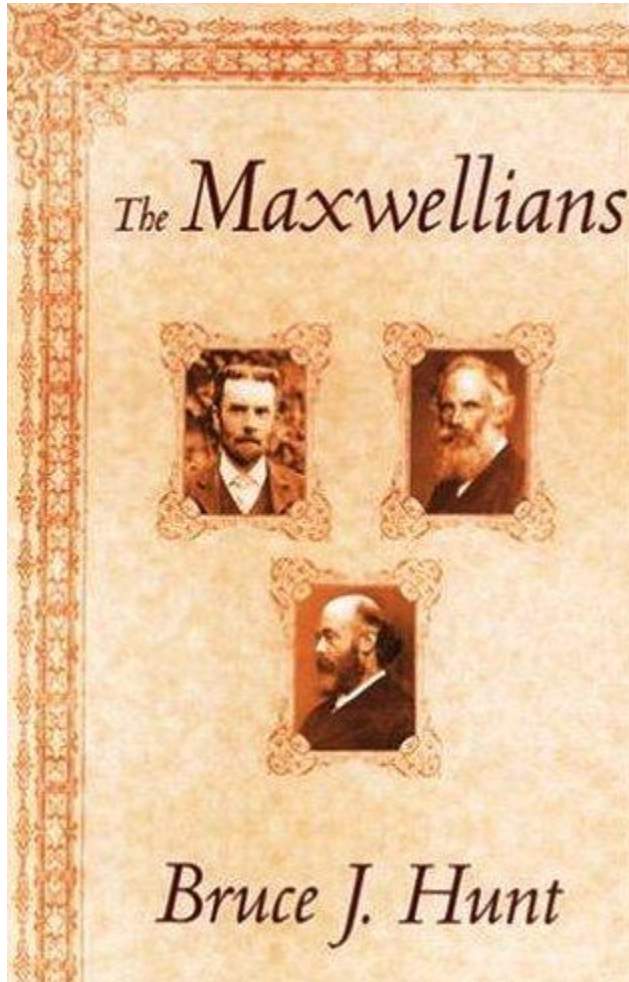

- **Bruce J. Hunt, *The Maxwellians*, Cornell University Press, 1991, ISBN 0801482348**

The End

This presentation will be archived at
<http://www.fars.k6ya.org/docs/k6oik>